

XIEGU

HF Portable Transceiver

G106

Operation Manual

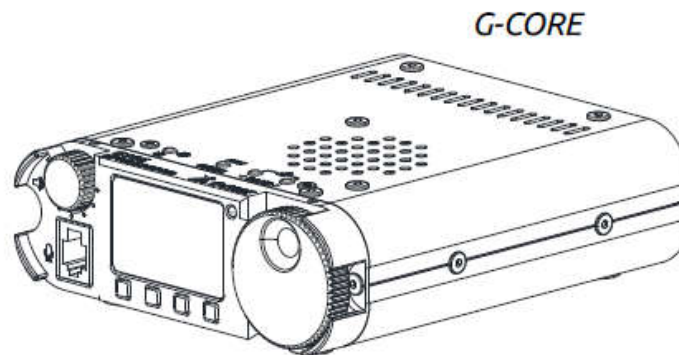

V1.30

Chongqing Xiegu Technology Co., Ltd.

G106 is a 5W portable QRP model with SDR circuit structure which uses 16bit-CODEC sampling and can deliver superior performance. The whole machine has SSB/CW/AM three modes and extra WFM (88~108MHz) receiving function, allowing you to listen to local FM broadcasts while communicating. Equipped with a CW digital filter with three bandwidths, it can help you connect to more and farther radio stations. With the external DE-19 digital adapter (optional), it can be easily connected to the computer and complete FT8 communication.

As an entry-level portable SDR transceiver, G106 will be a good helper for you to play CW and FT8.

Basic features:

- High-performance SDR core circuit
 - Compact and robust structure
 - Transmission and receiving of all amateur frequency bands within 3.8~29.7MHz
 - WFM broadcast receiving
 - Shortwave full-range continuous receiving
 - Amateur data communication available
 - Computer online control available
- Please read this Manual carefully for a better experience and full understanding on operation of the G106.

Panel Buttons

1. Volume knob

Turn the knob to increase or decrease the volume.

Short-press to switch the built-in/ hand microphone speaker.

2. Hand microphone interface

External hand microphone interface

3. Display

Black and white dot matrix display

4. T/R indicator

Status indicator

5. Main knob

Turn the knob to change the current frequency value;

6. Multi-function buttons

Short-press these buttons to execute corresponding functions displayed on the screen.

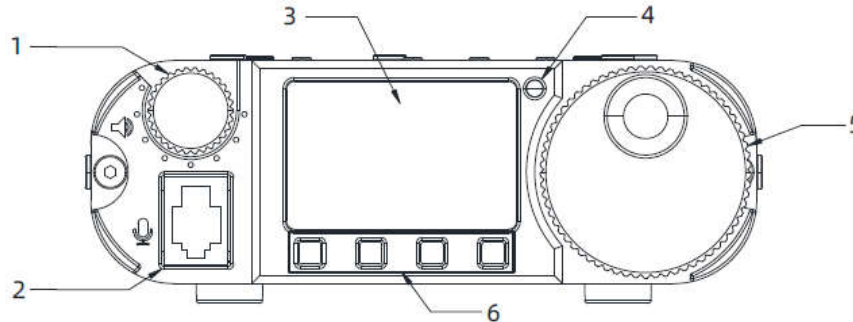

Panel Buttons

7. Power button/ screen backlight brightness

- Long-press the button to power on/ off.
- Short-press the button after power on to turn on/ off the display backlight

8. MODE button

- Short-press the button to switch between different working modes.
- Long-press the button to turn on/ off the preamplifier.

9 and 10. Band switch button/ lock/ Ts Step

- In the HF band, short-press these buttons to switch between frequency bands.
- Short-press these buttons in the WFM mode to switch between stored FM radio stations.
- Press these two buttons at the same time to lock all buttons and knobs.
- Press these two buttons at the same time again to unlock.
- Hold down press 9 or 10 buttons to adjust the frequency steps..

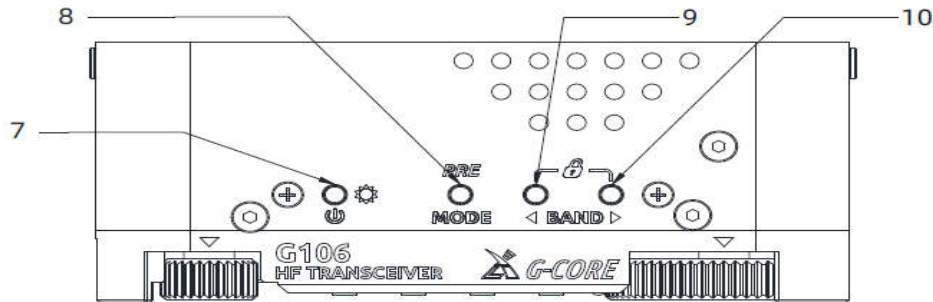

End Interfaces

11. Antenna interface

BNC interface with an impedance of 50Ω

12. KEY interface

3.5mm stereo socket (3-wire), used to connect a manual key or an automatic key (see Page 5 for the definition)

13. ACC interface

8-pin Mini-Din interface (see Page 5 for the definition)

14. Ground nut

For grounding cable of equipment

14. COM Interfaces

Communication interface

15. DCIN external DC power interface

5.5*2.5mm DC power socket

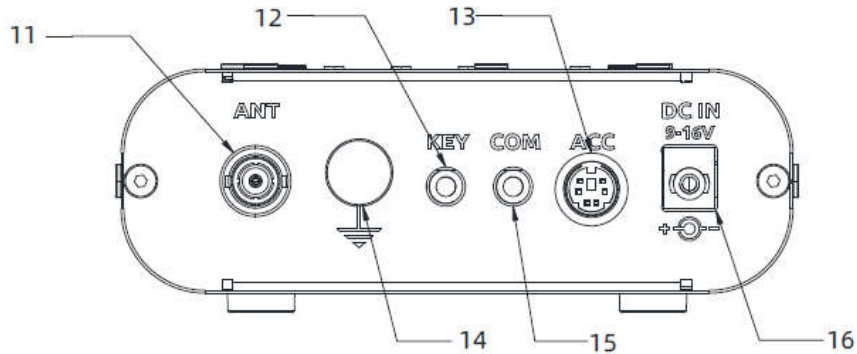

Instructions for External Interface Connection

1. MIC interface

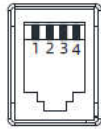

PIN1: PTT
PIN2: MIC+
PIN3: SPK+
PIN4: HCOM

Front Panel Facing G106

Note: There is a bias voltage at the MIC end, so it shall not be short-circuited.

2. COM interface

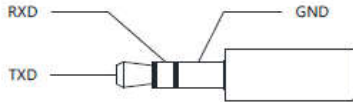

3. ACC interface

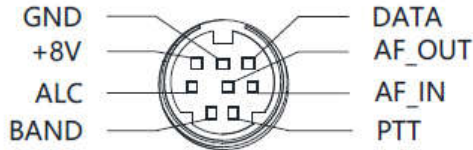

4. Key wiring diagram

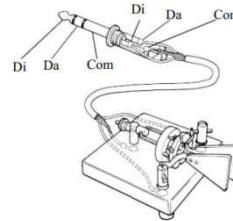

Note:

●If the connector of the straight key is a 6.5mm 2-pole plug, please change it to a 3-pole 3.5mm stereo plug according to the wiring method shown in the figure above, and connect the trigger end of the morse key to the "Di" or "Da" terminal.

5. Headphone jack



Headphone jack

The headphone jack is located at the bottom of the hand microphone, as shown in the picture.

■ Note: Before plugging in headphones, be sure to turn down the volume to avoid hearing damage.

Connection of External Power Supply

9-16V external DC power supply can be used for G106. The current load capacity of DC power supply shall be at least 3A. Attached power lines can be used to connect to radio and DC power supply.

DC power supply shall be connected in strict accordance with following figure to avoid reverse polarity connection.

The white-core line is connected to the positive pole of the power supply, and the metal-shielded line is connected to the negative pole of the power supply.

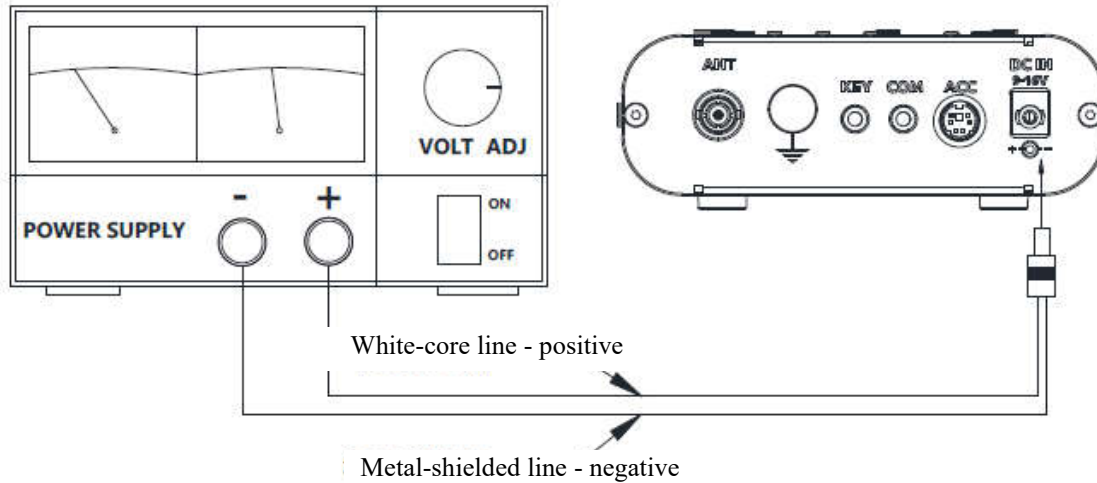

Connection of External Power Supply

EMC ferrite bead can be applied on power lines to prevent external disturbance from entering radio via power lines and radio-frequency interference in radio from radiating externally via power lines when external power supply is adopted for G106. Ferrite bead shall be installed at the side closing to power plug to greatest extent.

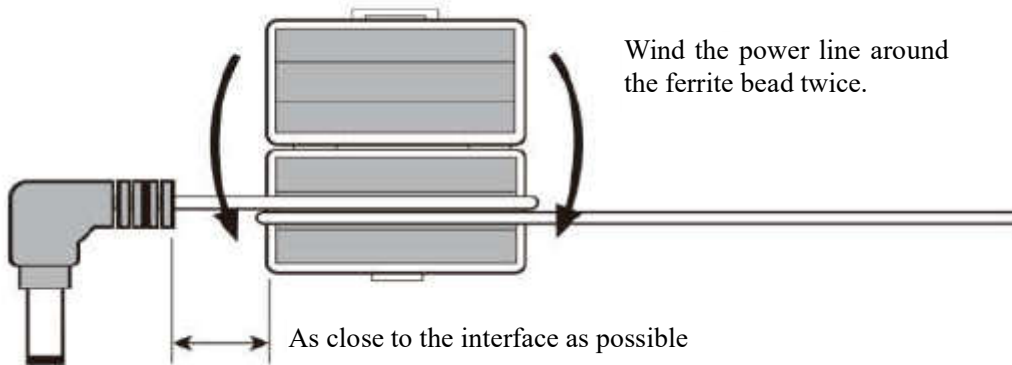

- Polarity of power lines shall be carefully inspected to avoid reverse polarity connection when external power supply is adopted.
- The limited warranty of the radio does not cover damage caused by an error in external power connection or damage caused by an abnormal power voltage.

Operation

G106 calls various functions through the multi-function menu. All functions are allocated to different menu pages and there are 4 function options on each page.

The menu items can be switched and called out in the following way:

- Short-press any multi-function button to call out the menu and turn the main knob to switch between the five menu pages in turn.

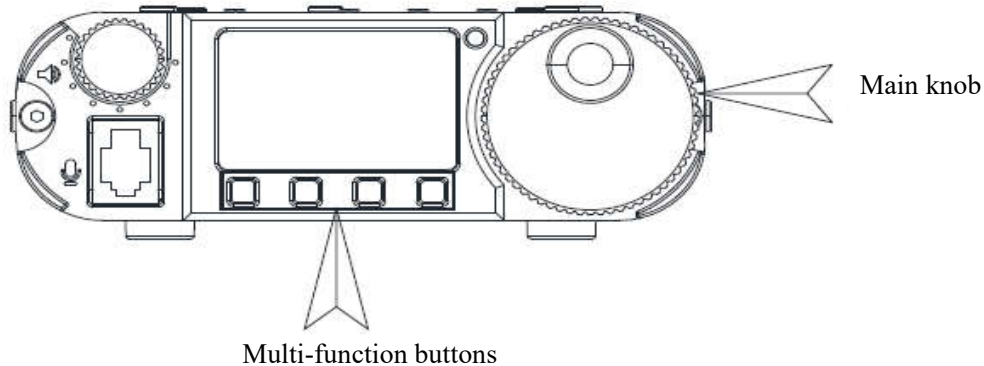

- Press the multi-function button corresponding to the menu displayed on the screen to execute the corresponding function.
- Some functions only work if you press "SAVE" after the adjustment. If you press "QUIT", you will directly exit from the current page and the current adjustment will not be saved.

Multi-function Menu Items

List of multi-function menu:

Menu Page	Menu Item			
1/5	V/M	A/B	MW	MC
	Frequency/ channel mode	VFOA-VFOB switching	Memory channel	Erase memory channel
2/5	CWF	CWT	CWR	QSK
	CW filter selection	CW sidetone	CW dot-to-dash ratio	QSK switch
3/5	KS	KM	IMB	CSN
	Automatic key rate	Key mode	IAMBIC mode	Startup information settings
4/5	SPL	DIS	BP	VER
	Pilot frequency mode	Display mode	Keypad tone	Version information
5/5	WFM	BSM	MG	/
	FM receiver	Band selection	Hand microphone gain	/

Operation

G106 uses a black and white dot matrix display screen to display all the status information of the whole machine, which is user-friendly. The visibility in outdoor sunlight is also very good.

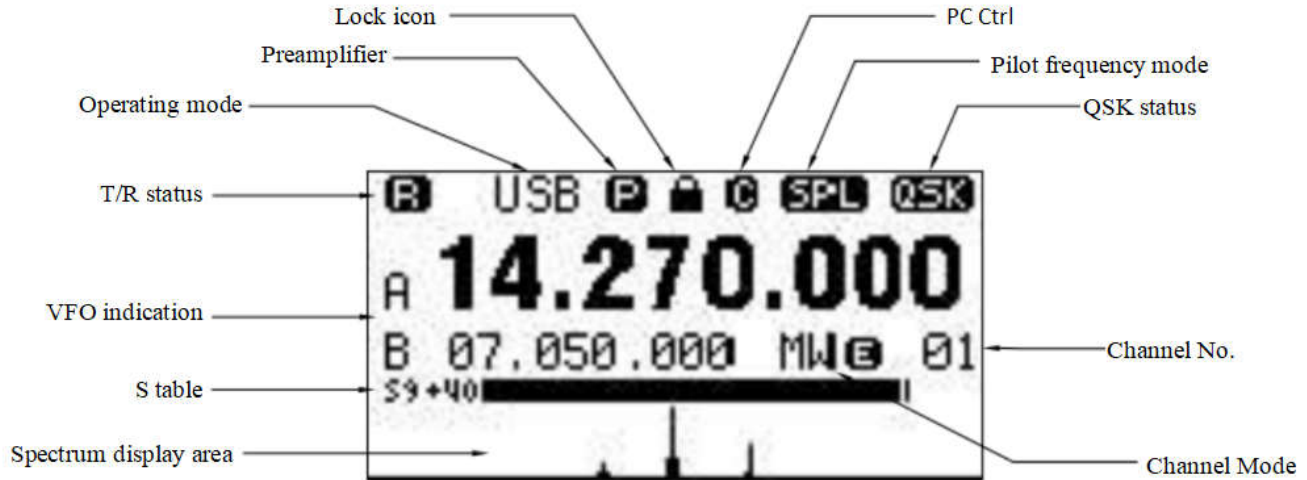

Operation

Basic operation

Turn on/ off the radio

Operation methods:

1. Short-press the power button to power on the G106 in the power-off state.
2. Long-press the power button for about 2s to power off the G106 in the power-on state.

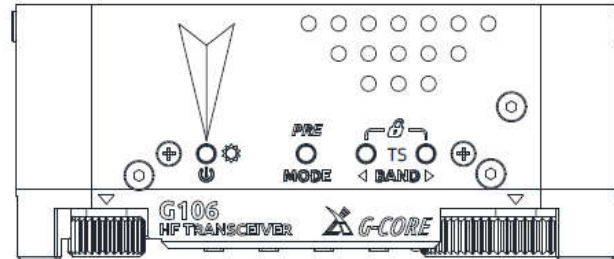

Turn off the screen in the power-on state

- Short-press the power button in the power-on state to turn off the backlight of the display.
- Short-press the power button again to turn on the backlight of the display.

Important reminder:

The current VFO frequency and other settings can be saved only when the machine is switched on and off correctly. Directly cutting off the external power supply will not save the current settings, and it will return to the state of the last correct shutdown after turning it on again.

Operation

Adjust the volume

Operation methods:

1. Turn the volume knob to the left or right to adjust the output volume.
2. Short-press the volume knob to switch between built-in speaker and hand microphone speaker.

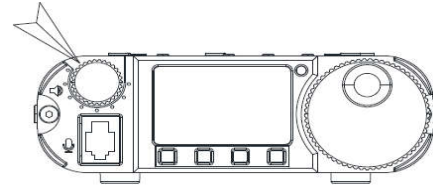

Operating frequency band and mode selection

Operation methods:

1. Press the MODE button at the top to switch to the corresponding mode.
2. Press the BAND left and right buttons to switch between the operating frequency bands in sequence:

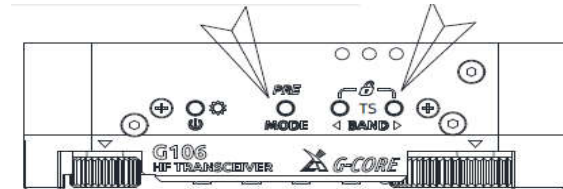

1.8MHz ↔ 3.5MHz ↔ 5.3MHz ↔ 7MHz ↔ 10MHz ↔ 14MHz ↔ 18MHz.....
21MHz ↔ 24MHz ↔ 28MHz

Set operation frequency

Operation methods:

TS step selection

TS step selection can be realized by the BAND buttons and the operation method is as follows: Long-press the BAND left or right button for 2s to step up or down.

Adjust the frequency

1. Short-press the BAND buttons to adjust to the desired frequency band.
2. Adjust the TS step and then turn the main knob to set the desired frequency.

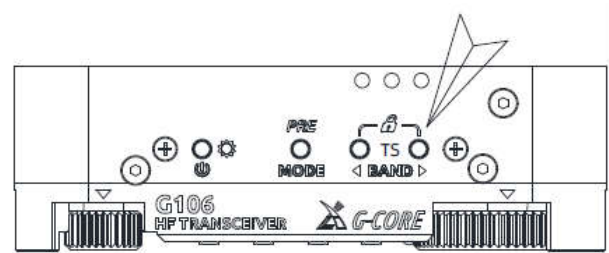

Operate the preamplifier

Operation methods:

Long-press the MODE button to turn on/ off the preamplifier. The logo "P" will appear at the top of the display.

Note:

Turn off the preamplifier to prevent the receiver from overloading if the external signal is strong or the interference of the environmental radio wave is great.

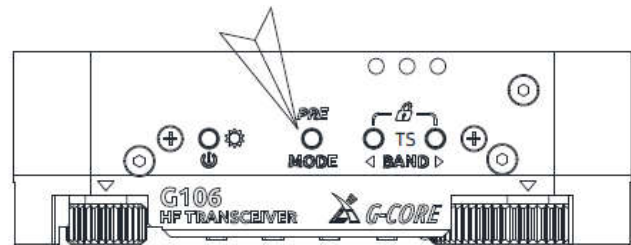

Operation

Inter-frequency transceiver SPL

There are two independent VFOs inside the G106 transceiver, which can set different frequencies and modes respectively.

Operation method:

1. Call up the multi-function menu [1/5] and select the A/B function to switch between VFO-A and VFO-B.
2. Set the operating frequency and mode of VFO-A and VFO-B respectively.
3. Call the multi-function menu [4/5] and select the SPL function. At this time, the "SPL" icon on the screen lights up, indicating that the SPL function is turned on.

Notice:

The large font frequency number in the VFO area of the screen is the receiving frequency, and the small font frequency number is the transmitting frequency.

Tips:

You can make full use of VFOA/B to set different frequencies or modes, and quickly switch between two frequency points in real time.

Transmit in CW mode

Insert the straight key or morse key into the KEY interface at the end of the G106 (see Page 5 for the definition of wiring)

Operation methods:

1. Insert the morse key plug into the KEY port;
 2. Turn on QSK function in menu and set appropriate rate;
 3. Press the morse key to enable CW communication.
 4. Call the multi-function menu [2/5], choose the CWF function, and turn the main knob to select the filter bandwidth (three bandwidths, i.e. 500Hz, 250Hz and 50Hz, are available). Press SAVE to save the selection and exit, and the selected parameter will work.
 5. Call the multi-function menu [2/5], choose the CWT function, and turn the main knob to select the CW receiving sidetone frequency. Press SAVE to save the selection and exit, and the selected parameter will work.
- If the QSK function is disabled in the menu, there will be only CW sidetone of transceiver after the morse key is pressed, but signals will not be transmitted externally.

Set CW related parameters

KS: automatic key rate setting

KM: manual/ auto mode selection

IMB: IAMBIC mode selection

QSK: QSK on, off / long press for 2 seconds to adjust the CW transceiver switching delay.

Operation

Data communication

G106 supports the amateur data communication mode, and supports the function control of the radio station by the computer software.

Operation method:

1. Use the DE-19 adapter to connect the G106 to the computer (see page 21 for wiring definitions). Once communication with the computer is established, the character "C" will be displayed at the top of the screen.

Press the MODE button at the top to select the working mode of G106 according to the amateur data communication mode:

L-D: lower sideband data transmission mode

U-D: upper sideband data transmission mode.

3. Adjust the sound input amplitude and sound output amplitude of the computer within the appropriate range.

Notice:

When the L-D or U-D mode is selected, the G106 will automatically disable the hand microphone, and obtain the external audio input from the ACC interface.

The size of the external input audio is adjusted to a suitable level by the external device.

Lock button

Operation methods:

1. Press and hold the two BAND buttons at the same time for about 2s to lock the buttons and knobs (except the power button and volume knob), and a lock sign will be displayed at the top of the screen.
2. Long-press the two buttons again to unlock.

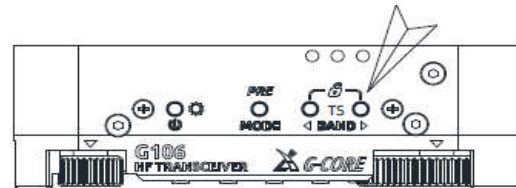

Operation

FM radio operation

G106 can receive FM broadcast and the operation method is as follows:

1. Call the multi-function menu [5/5] and select the WFM function to go to the FM radio interface.

2. Functions of buttons:

① </> button at the bottom of the screen: Up and down to automatically search for radio stations. Automatically store the radio station found and stop.

② QUIT: Quit FM radio.

③ Main knob: Manually adjust the radio frequency.

④ BAND left and right buttons: Switch between radio stations that have been automatically stored.

3. Adjust the volume knob to change the volume.

Channel storage and clearing

Operation methods:

Store channel:

1. Select the desired frequency and set the relevant mode, status and other items.

2. Call the multi-function menu [1/5] and select the MW function. Turn the main knob to select a desired empty channel. Then, flashing "MW" will be displayed on the screen, next to which, there is an icon "E", indicating that the current channel is empty and can be stored. Press "SAVE" to save the channel.

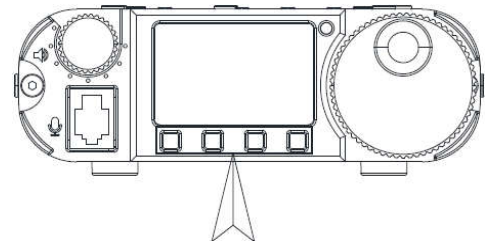

Operation

3. If you press "QUIT", you will directly exit from the current page and the channel will not be saved.
4. In channel mode, short-press the BAND left and right buttons to switch between the stored channels.

Delete a channel:

1. In channel mode, select the channel to be deleted.
2. Call the multi-function menu [1/5], choose the MC function and select "CLR" to delete the current channel. If you press "QUIT", you will directly exit from the current page and the channel will not be deleted.

Note:

- When storing a channel, if the channel you choose is not empty and you decide to continue the operation, the current frequency will be stored to the channel and the previously stored information will be overwritten.

Set startup display information

The radio station call sign of G106 can be edited and displayed on its startup interface.

Operation methods:

1. Call the multi-function menu [3/5] and select the CSN function to go to the information editing interface.
2. The three function buttons on the editing interface are defined as follows:
 - QUIT: give up editing and exit
 - BACK: delete the last character
 - SAVE: save and exit
3. Turn the main knob, choose the desired character and press the main knob to select the character.
4. Press the SAVE button to save and exit. The information you edited will be displayed on the startup interface the next time you turn it on.

Operation

Set display mode

The display mode of the main interface of G106 can be set and the operation method is as follows:

1. Call the multi-function menu [4/5], and choose the DIS function to go to the display mode selection interface where three display modes, i.e. SCOPE+S, SCOPE and BIG SCOPE, are available:

SCOPE+S: display mode of spectrum + S table

SCOPE: display mode of spectrum only

BIG SCOPE: display mode of large format spectrum

2. Turn the main knob to select the desired display mode, press SAVE to save and exit. About 5s later, the interface will automatically switch to the normal display state.

Tips: If the bottom menu is already displayed, you may short-press the main knob to quickly return to the spectrum display state.

Enable/ disable keypad tone

Operation methods: Call the multi-function menu [4/5], choose the BP function and press the BP function button again to enable/disable the keypad tone.

BSM band selection

G106 can choose to switch frequency bands in sequence in all frequency bands, or only in amateur frequency bands. The operation methods are as follows: 1. Call the multi-function menu [5/5], select the BSM function, and enter the frequency band selection. There are two frequency band modes to choose from:

FULL BAND: Full Band Mode

HAM BAND: Amateur Band Mode

2. Press the BSM key again to select the desired frequency band mode.

MG hand microphone gain adjustment

G106 can set the microphone gain of the hand microphone, the operation method is as follows:

1. Call the multi-function menu [5/5], select the MG function, and enter the handset gain setting interface.
2. Rotate the main knob to set the gain parameter. After selection, press SAVE to save and exit, the parameters will take effect.
3. The default gain of the system is set to "20".

View software version information

Operation methods:

1. Call the multi-function menu [4/5] and choose the VER function to go to the firmware version information display interface. The displayed information is as follows (example):

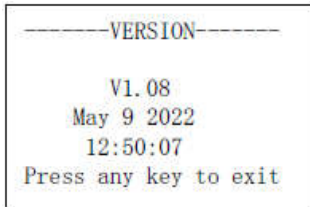

2. Press any button to exit the current interface.

Restore factory default parameters

Method:

In the off state, press and hold the MODE button to power on.

This reset function only restores various user-adjustable parameters, and the channel data stored by the user will not be cleared.

Connection with XPA125B and computer

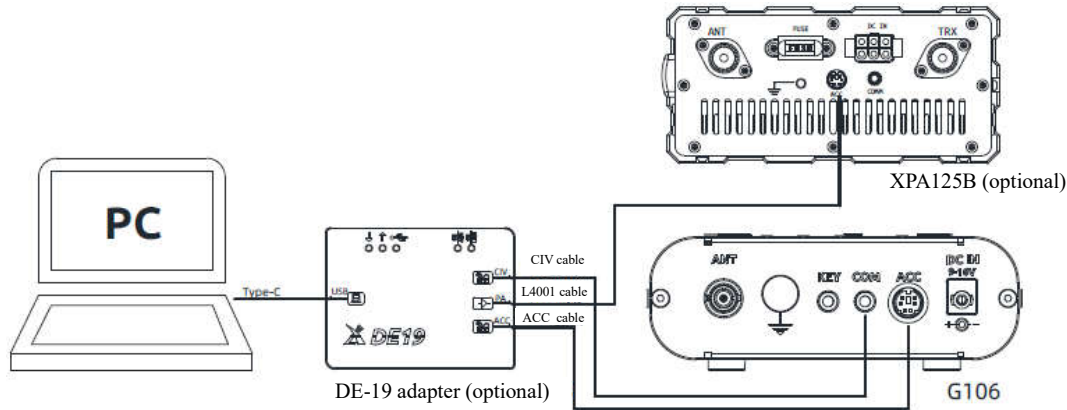

G106 can be connected to computer and XPA125B through DE-19 adapter, which is convenient for data communication and power expansion.

1. Complete the connection as shown in the figure above.
2. The CH342 port driver shall be installed, or the driver tool may be used to install it online.
3. Select the model "XIEGU G90" on the data communication software (or control software) to complete the connection.
4. Choose the sound card virtualized by DE-19 for sound input/ output. Note that different sound devices are required for the input and output.

Note: If you choose other models compatible with C-IV instructions, some instructions may not be responded to.

Appendix 1

Computer control instructions

G106 adopts C-IV instruction sets. You can remotely control the transceiver based on standard instructions of the instruction set or configure control instructions of other software to enable the control over G106.

Wave band voltage data

The ACC interface of G106 provides wave band data of four frequency bands, which can control the peripheral device to automatically switch the wave band or identify the wave band information for other devices.

Wave Band	Voltage	Wave Band	Voltage	Wave Band	Voltage	Wave Band	Voltage
/	/	7MHz	920mV	18MHz	1610mV	28MHz	2300mV
3.5MHz	460mV	10MHz	1150mV	21MHz	1840mV	/	/
5.0MHz	690mV	14MHz	1380mV	24MHz	2070mV	/	/

Specification Parameters

Specifications

Receiving frequency:	0.55~30MHz	88~108MHz (WFM)
Transmitting frequency:	3.5~3.9MHz 10.1~10.15MHz 18.068~18.168MHz 24.89~24.99MHz	5.3515~5.3665MHz, 7.0~7.2MHz 14.0~14.35MHz 21.0~21.45MHz 28.0~29.7MHz
Operating mode:	SSB/CW/AM, WFM (receive only)	
Receiving sensitivity:	CW: 0.25uV @10dB S/N SSB: 0.5uV @10dB S/N AM: 10uV @10dB S/N	
Frequency stability:	±1.5ppm within 30min after power on @25°C: 1ppm/hour	
Transmitting power:	≥5W @13.8V DC	
Transmitting spurious suppression:	≥50dB	
Audio output power:	0.3W	
Operating voltage:	9~15V DC	
Standby current:	0.37A @Max	
Transmitting current:	2.8A @Max	
Dimensions:	120*40*135 (mm)	
Weight:	About 720g (only host)	

- All specifications are typical and apply to amateur bands only. Due to technical improvements, the above specifications are subject to change without notice.

- The operating frequency range of transceivers sold in different countries or regions will be set according to local regulations. Ask local dealer for details.

Packing List

Packing list

Item Name	Qty.
G106 host	1 set
Standard hand microphone	1 no.
Power line	1 pc.
Warranty card	1 copy
Manual	1 copy
Certificate of conformity	1 copy
USB data cable	1 pc.

*Optional supporting products

- **DE-19:** external USB communication adapter (applicable to G90, G90S, G106), which can be used for computer control and data communication.
- **XPA125B:** 100W power amplifier and antenna tuner AIO
- **L4001 cable:** dedicated control cable for connecting XPA125B (applicable to X6100, G106).

Copyright Statement

Copyright © 2022

All rights are reserved by Chongqing Xiegu Technology Co., Ltd. Reproduction of any part of this Manual without permission is prohibited.

V1.30

XDC-A00